

Coast Awning Wall Kits



Increase your outdoor living space with Coast to Coast's stylish and easy to install Awning Wall Kits for Pop Top Caravans

Before you begin, please note the following:

- Coast Awning Wall Kits are available to suit rollout awnings from 12ft—18ft (3.66mt—5.47mt) in 1ft increments.
- To ensure you purchase the correct size Awning Wall Kit, it is recommended that you measure the width of your rollout awning from the centre of the left arm to the centre of the right arm. *Please refer to the diagram below:

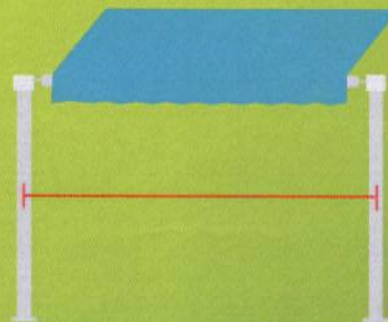

- Once you are ready to begin installation, park your Pop Top in a desired position, make sure the hand-brake is on and your van is level front-to-back and side-to-side.

Sizes Available:

150-03000	AWNING WALL KIT TO SUIT 12' ROLLOUT AWNING	150-03010	AWNING WALL KIT TO SUIT 13' ROLLOUT AWNING
150-03020	AWNING WALL KIT TO SUIT 14' ROLLOUT AWNING	150-03030	AWNING WALL KIT TO SUIT 15' ROLLOUT AWNING
150-03040	AWNING WALL KIT TO SUIT 16' ROLLOUT AWNING	150-03050	AWNING WALL KIT TO SUIT 17' ROLLOUT AWNING
150-03060 AWNING WALL KIT TO SUIT 18' ROLLOUT AWNING			



Patio Position

Step 1

- Extend/ open your Pop Top roof
- Rollout your awning to the patio position
- Take the pull-down strap out of the awning roller tube

Step 2

- Peg/ secure the awning legs to the ground
- It is recommended to set the front roller tube height to 6'1" (1.86m) on the left and right side of the awning (measuring from the bottom of the roller tube to the ground)
- Unpack your Awning Wall Kit and locate the front wall panel—this has zips at both ends

Front Wall

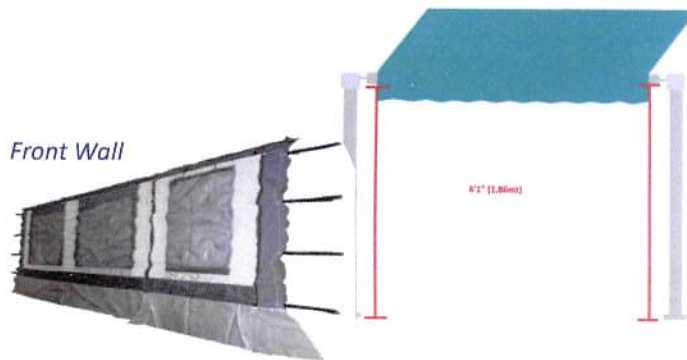

Step 3

- Unzip the transition piece from the front wall (this makes threading it through the rope track on your roller tube much easier)
- With the zipper facing you, thread the transition piece through the rope track
- Ensure the transition piece is now positioned in the middle of the roller tube. You can check this by measuring the distance from the end of the transition piece to the end of the roller tube on the right side. Once you have this measurement, compare it to the left side.



Step 4

- It's now time to attach the front wall to the transition piece
- Make sure the flyscreen is facing you and clip the front wall to the transition piece using the caribee clips
- Once this is done, you can zipper the two pieces together, creating a solid barrier against the elements

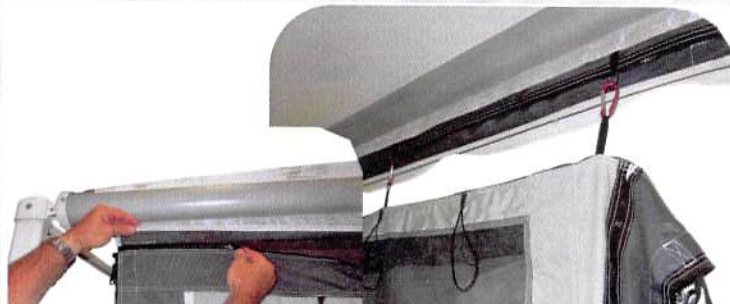

Telescopic
Rafter
Pole

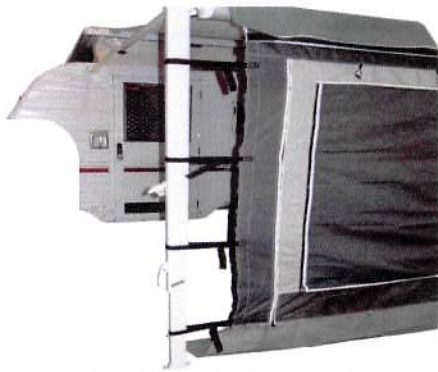

Step 6

- Line the edge of the telescopic rafter pole to the edge of the front wall (not awning fabric)—the spot which the spigot points is where you should drill a pilot hole into the awning roller tube
- It is recommended to make the pilot hole 20mm under the awning canopy and 12.5mm in from the edge of the **front wall**

**Note: When drilling the final hole, be careful not to over penetrate the roller tube. If you go too far, you risk damaging the internal spring mechanism. It is recommended to use a 11/32" (8.73mm) drill bit to drill your final holes.*

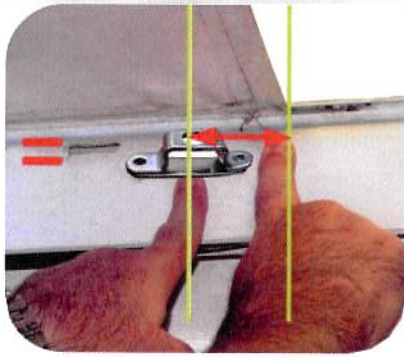
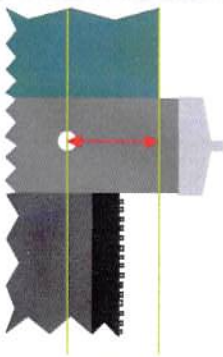

Step 8

- The end of the telescopic rafter pole which has a thicker circumference needs to have its spigot trimmed down to 15mm. Once this is done, insert the telescopic rafter pole into the bracket on the pop top and the hole in the roller tube
- At this point you will need to make a decision on whether you want to continue the installation process using sail track (which will have to be screwed onto the outside wall of your RV) or if you want to use the tent poles provided

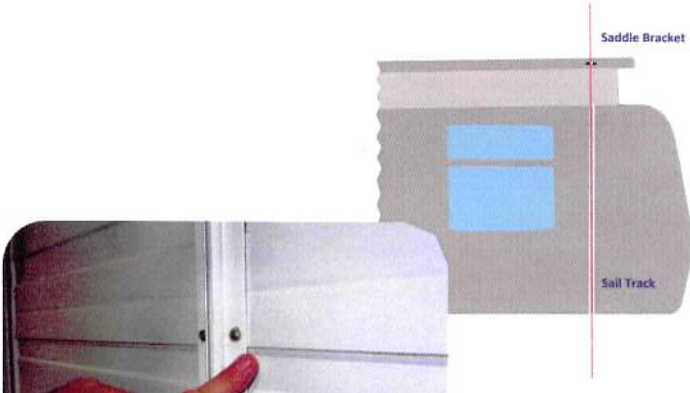

Step 5

- Tie the black webbing straps on the ends of the front wall to the awning arm by threading through the buckle (there are 4 on each side of the front wall)
- Once you have tied up both sides, make sure the front wall is still centralised on the roller tube of the awning
- Locate the telescopic rafter pole (this is the one with spigots on both ends)

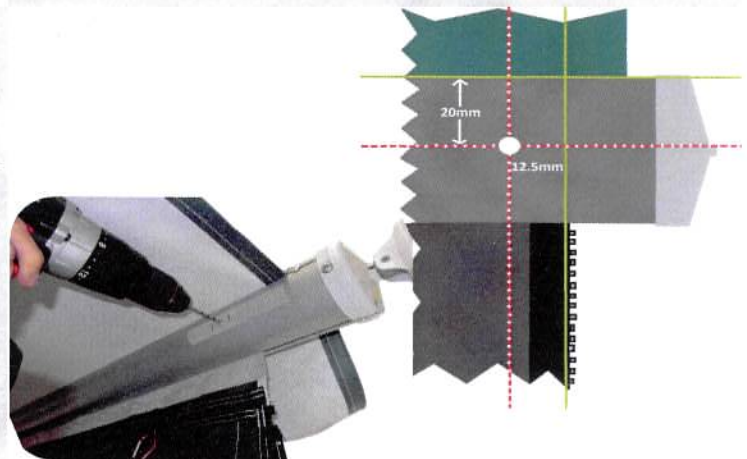

Step 7

- Remove any burrs from the drill site—you can use a round metal file to smoothen the edges
- Locate the saddle brackets—these need to be installed onto the top fascia of your Pop Top roof approx. 20mm under your awning vinyl

**Note: Ensure that the centre hole of the saddle bracket measures the same distance from the edge of the awning canopy as the drilled hole on the roller tube*

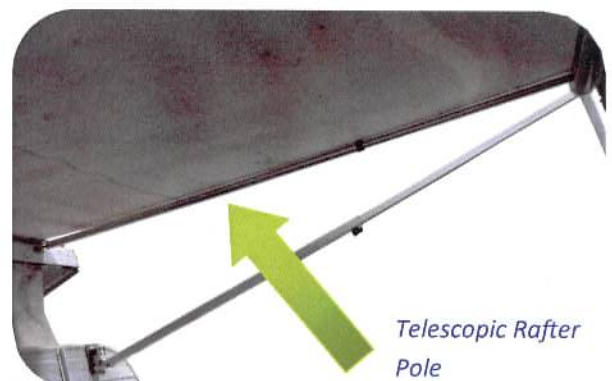

Sail Track—Step 1:

- Coast recommends the use of double sided sail track but you may find that near window/ door frames space is limited—in this instance, single sided sail track is fine
- The sail track should be installed directly below (and in-line) with the saddle bracket
- When installing the sail track remember to use stainless steel screws and ensure they are applied to your RV's cladding joints



Sail Track—Step 2:

- Use a foam tape like 3M on the underside of the sail track prior to screwing, this creates a sealant and also fills the recesses on your RV outer wall
- File any sharp edges away and flare the ends of the sail track
- Measure the distance from the sail track to the front wall of the kit

Sail Track—Step 3:

- Locate a side wall panel (these are the ones with two windows) and unroll it flat on the ground
- Measure the width of the side wall panel as it will need to be the same as the width from the sail track to the front wall panel
- Each side wall panel can be adjusted to fit varying projection widths by means of adjustable infill panels. For your convenience, each kit comes with two S, M and L infill panels

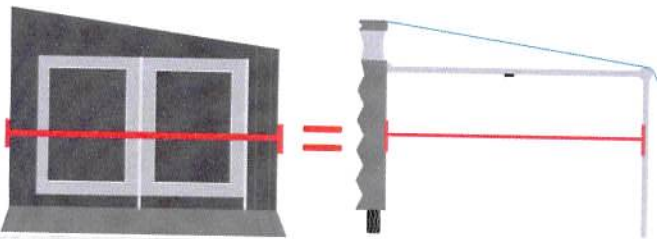

Sail Track—Step 4:

- Use the appropriate infill panel and attach to the side wall panel by means of the extra wide (50mm) Velcro strip. You may find that you don't need an infill panel at all but this depends on your awning projection
- Measure the width of the side wall panel you've just created and make sure it is the same as the distance from the sail track to the front wall panel

Sail Track—Step 5:

- You now need to thread the telescopic rafter pole through the loops on the inside of the side wall panel. To do this you need to measure the floor—vinyl height at the front of the awning and the back of the awning
- Line the telescopic rafter pole up with the first and last loops that you need, this will indicate which of the remaining loops the pole should go through
- There are x5 elasticized pole clips for each side wall. Tie these (as markers) to the loops that the telescopic rafter pole should go through



Sail Track—Step 6:

- Thread the telescopic rafter pole through the loops with the elasticised clips on it
- Pick up the side wall panel by the pole (and remember that the flyscreen should face you) and insert each spigot end into its corresponding hole on the roller tube and the



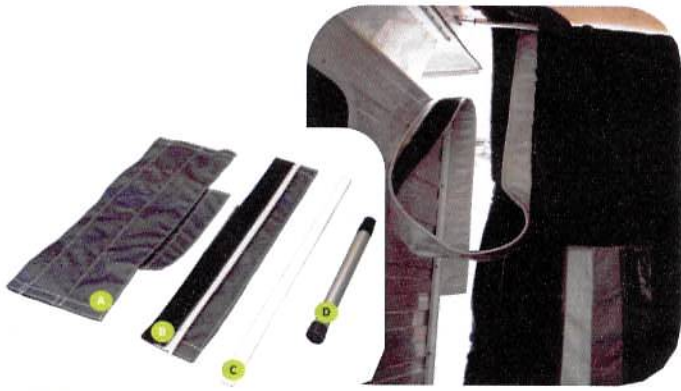

Sail Track—Step 7:

- Attach the side wall to your RV by threading the white strip into your sail track, the easiest way to do this is by detaching this from the side wall and then firmly pressing the Velcro back together once threaded
- Locate the pop top insert components
- Adjust the height of the small telescopic pole (D) so that it fits snugly into the cavity under your pop top roof

Sail Track—Step 8:

- Once you have the correct height, insert the small telescopic pole into the insert housing (A)
- Put this into the cavity under our pop top roof. The foam will fill all the gaps but if you feel there is too much foam, you can trim it according to your preference
- The Velcro on (A) should then be attached to the Velcro on (B). The piping on (B) can then be threaded into one side of the pipe track (C)



Tidy the extra strapping by using the black bands supplied

Sail Track—Step 9:

- Thread the white strip (on your side wall panel) through the other side of the pipe track, this eliminates any gaps and thus prevents any wind from entering at this point.

**Note: You may attach (A) directly onto your side wall panel by simply attaching the two Velcro pieces together.*

- For the finishing touches on the side wall, simply roll up the excess material and clip it onto the telescopic rafter pole by using the elasticised clips
- You can also cut strips into the PVC near the roller tube to achieve a flush fit
- You need to attach the awning vinyl to the side wall, this is done by clipping the suspender buckles to the canopy. We've included a vinyl strip to protect your awning vinyl

Pole—Step 1:

- Follow the steps as previously outlined (on how to attach the front and the side wall panels)
- With the side wall in position, locate a telescopic pole (one end has a rubber foot and the other has a U-shaped clip), this needs to be inserted into the pole cavity on the side wall panel
- Open the receiving pocket and slot the telescopic pole inside, keeping in mind that the U-shaped end should be firmly clipped onto the telescopic rafter pole (that the side wall is hanging off of)
- Close the pole cavity

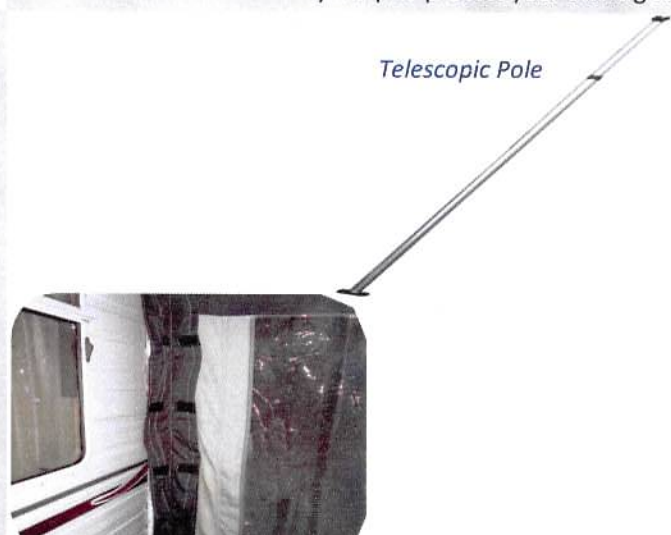

Telescopic Pole

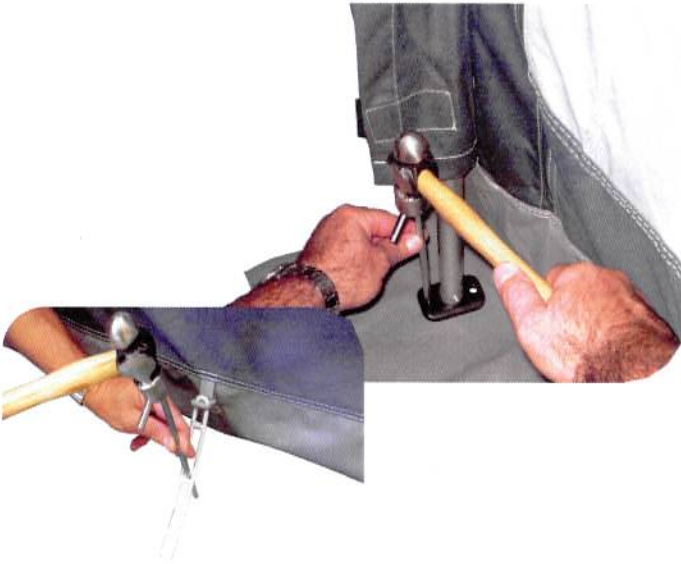

Pole—Step 2:

- Line up the holes on foot of the telescopic pole, to the holes in the mudflap of the side wall
- Secure/ peg the foot to the ground
- **To attach the second wall, simply follow the steps as outlined, dependant on your method of installation**
- Now that all your walls are up, you need to secure them to the ground
- To do this, hook the ladder straps into the x-clips (these are found on the outside of all walls)
- Use the tent pegs provided to secure the ladder straps to the ground

Draft Skirt—Step 1

- Attaching the draft skirt to your Pop Top stops the cold breeze from getting into your new living space
- You will need to install a series of press studs onto the wall of your Pop Top
- Find a line that runs near the bottom of your Pop Top (we recommend you get as close to the floor line as possible so that you drill into the timber or aluminium backing)

**Note: Remember to use stainless steel screws and seal them with silicone thus preventing nasty rust streaks.*



Draft Skirt—Step 2

- Once you've installed your press studs, grab the PVC material for the draft skirt
- Line it up with the press studs in your Pop Top and use this as a guide as to where to insert the receiver press studs into the material.
- Once you've inserted all the receiver press studs into the material, you can attach the draft skirt to the Pop Top



Draft Skirt—Step 3

- You can trim it down to the size you need and for a neater fit, trim around any obstacles such as door frames or door stoppers
- Locate the second piece of material and size it up against your wheel arch, trim any unnecessary/ extra material away
- Install press studs onto your Pop Top wall taking care to follow a straight line as close to your Pop Top's joinery as possible

**Note: For a more comprehensive guide to installing press studs, please refer to the information on the last page of this Instruction Guide*

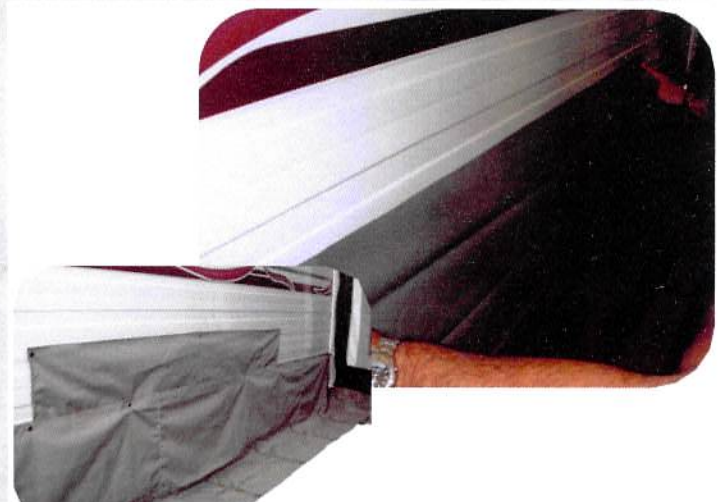

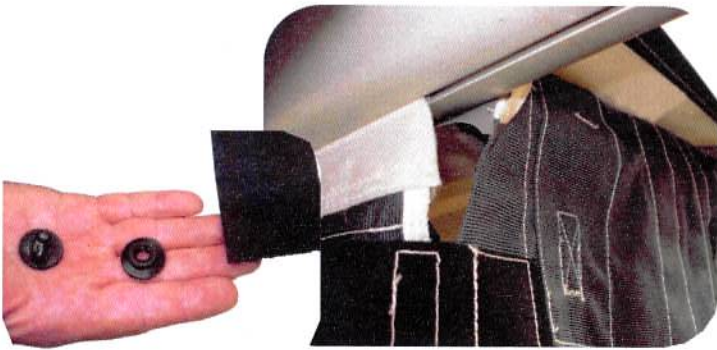

Optional Extra—Step 2

- Use the spike to make a hole for a stay-put in the 200mm piece of loop Velcro, this should go through the side wall material too (DO NOT use a drill)
- The female part of the stay-put goes into the side wall, press the male part (along with the loop Velcro) into it

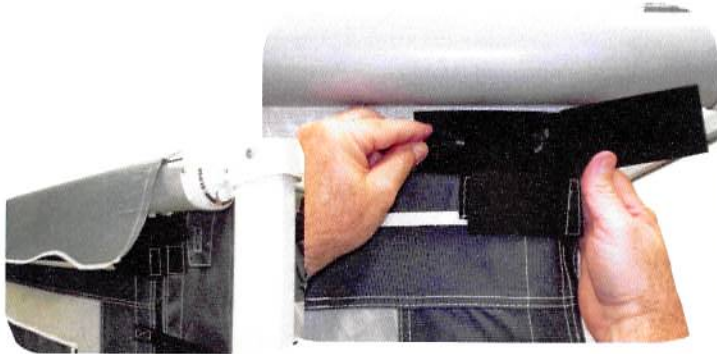

Optional Extra—Step 1

- Due to the projection of your awning and the position of the track in your roller tube, there may be a gap between the front wall and the side wall
- If you would prefer that this is closed, we've included a Velcro Stay-Put Kit. To fit this, you will need an 8mm spike and a pair of scissors

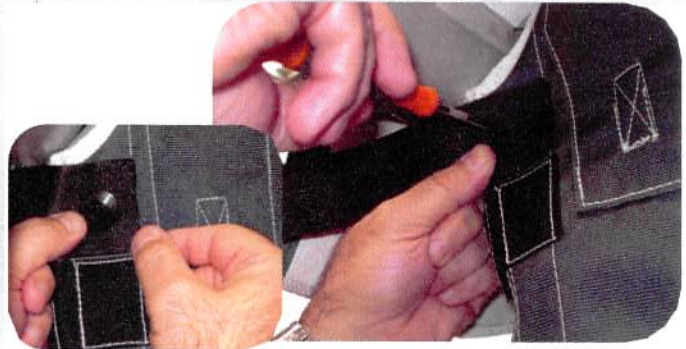

Optional Extra—Step 3

- Now fit the 130mm piece of hook Velcro to the front wall, the same method applies except that it will need x2 stay-puts (positioned 30mm from each end)
- Once this is done, simply attach the loose piece of loop Velcro (from the side wall) onto the hook Velcro (on the front wall) —no more gap!

Instructions for Press Studs:

1. Place a stainless steel screw (which you have pre-purchased) through (C) - this is the receiver press stud
2. Screw the receiver press stud into the wall of your Pop Top—Coast recommends that you follow steps 1—9 as per the diagram for the draught skirt and steps a—c for the wheel cover
3. Pierce a hole into the draught skirt material where you want the cap stud to appear. Feed the shank of (A) through the hole in the material and position on the disc supplied
4. Place (B) on the of shank (A). Holding the punch straight, hit sharply with a hammer to close/ set the two pieces firmly onto the draught skirt material. (Diagram 1)
5. Press this onto the receiver stud (on your Pop Top) - repeat the process until the draught skirt is on

**Note: Depending on the length of your Pop Top and depending on how taught you want the draught skirt to be positioned, you may find that extra press studs are required. Coast's recommendation as to press stud placement is to be used as a guide only.*

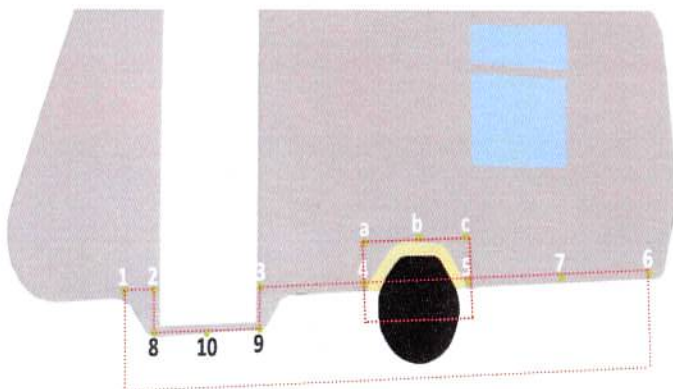
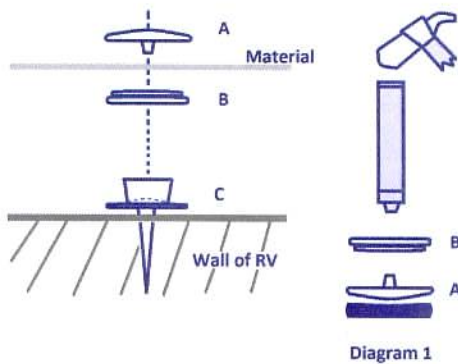

Things To Note:

- If you have any queries regarding any aspect of the installation process, please contact a Coast to Coast product stockist **BEFORE** you commence installation.
- Your awning roller tube should be set at 6 'o clock, i.e. the third grooved track is facing straight down. *(Refer Diagram 2)*
- Should you leave your RV for any period of time or you are turning in for the night, it is imperative that you either raise one of the awning legs, or lower one of the awning legs. You can do this with your Awning Wall Kit already set up. This will eliminate damage to your awning and your Awning Wall Kit as a result of rain pooling on your awning canopy. *(Refer Diagram 3)*

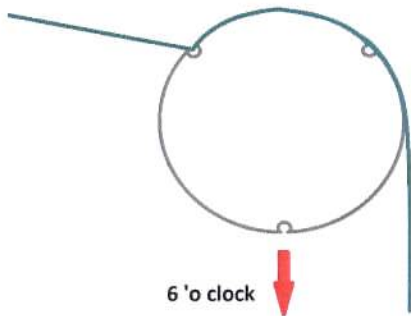

Diagram 2

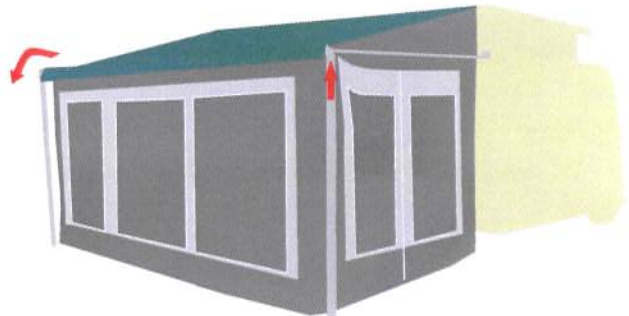

Diagram 3

Coast to Coast Awning Wall Kits are also available for Caravans and Motorhomes. Please contact your nearest Coast to Coast product stockist for more information.

To locate your nearest Coast to Coast product stockist, please ring a Coast to Coast branch in your state:

NSW (Head Office)	VIC	QLD	WA	NZ
P: 02 9645 7600	P: 03 9305 6566	P: 07 3805 7117	P: 08 6253 8088	P: 09 274 8700
E: salesnsw@coastrv.com.au	E: salesvic@coastrv.com.au	E: salesqld@coastrv.com.au	E: saleswa@coastrv.com.au	E: enquiry@coastrv.co.nz

For technical assistance, please email: technical@coastrv.com.au

