



**IWH-1.5-13.5** Instantaneous Gas Water Heater

**Installation and Operating Instructions**

Part Numbers: 051460 (Black Door); 051459 (White Door)

The IWH-1.5-13.5 instantaneous gas water heater is designed in accordance to the Australian Standards for installation in recreational vehicles. This water heater is not for use in houses, space heating or marine application.

This water heater is designed to produce water with a temperature rise of 37°C above ambient, at a flow rate of 5 litres per minute. Exceeding the flow rate will result in cooler water. If the ambient temperature is very low (i.e. close to freezing), the water in the supply tank will be cold, resulting in cooler than expected water.

**WARNING:** If the information in these instructions is not followed exactly, a fire or explosion may result causing property damage, personal injury or loss of life.



Do not store or use gasoline or other flammable vapors and liquids in the vicinity of this or any other appliance.

**WHAT TO DO IF YOU SMELL GAS**

- Evacuate all persons from the caravan or RV.
- Shut off the gas supply at the gas container or source.
- **DO NOT** touch any electrical switch or use any phone or radio in the vehicle.
- **DO NOT** start the vehicle's engine or electric generator.
- Contact the nearest gas supplier or qualified service technician for repairs.
- If you cannot reach a gas supplier or qualified service technician, contact the nearest fire station or emergency services.
- **DO NOT** turn on the gas supply until the gas leak(s) has been repaired.

Installation, commissioning and service must be performed by a licensed gas fitter, service agency, OEM or the gas supplier. Failure to do so will void the warranty.

	<b>WARNING:</b> To avoid scalding, water supplied to the shower and hand basin must pass through a tempering valve to restrict the water temperature to 50 degrees C. We recommend the John Guest tempering valve 12mm – code 042586.
	<b>WARNING:</b> Installation of this product must comply with the requirements of the Plumbing Code of Australia (PCA)
	<b>WARNING:</b> Do not block any pressure relief valves if fitted when installing this Hot Water System.

	<b>WARNING:</b> THIS APPLIANCE MAY DELIVER WATER AT HIGH TEMPERATURE. REFER TO THE PLUMBING CODE OF AUSTRALIA (PCA), LOCAL REQUIREMENTS AND INSTALLATION INSTRUCTIONS TO DETERMINE IF ADDITIONAL DELIVERY TEMPERATURE CONTROL IS REQUIRED.
	<b>WARNING:</b> FOR CONTINUED SAFETY OF THIS APPLIANCE IT MUST BE INSTALLED OPERATED AND MAINTAINED IN ACCORDANCE WITH THE MANUFACTURERS INSTRUCTIONS.



### Critical Installation Warnings

- Install in recreation vehicles only. RV's are recreation vehicles designed as temporary living quarters for recreation, camping, or travel use having their own power or towed by another vehicle.
- All combustion air must be supplied from outside the RV, and all products of combustion must be vented to outside the RV.
- **DO NOT** vent water heater with venting system serving another appliance.
- **DO NOT** vent water heater to an outside enclosed porch area.
- Protect building materials from flue gas exhaust.
- Install water heater on an exterior wall, with access door opening to outdoors.
- **DO NOT** modify water heater in any way.
- **DO NOT** alter water heater for a positive grounding system.
- **DO NOT** HI-POT water heater unless electronic ignition system (circuit board) has been disconnected.
- **DO NOT** spray aerosols in the vicinity of the appliance while it is in operation
- **DO NOT** place articles on or against this appliance
- **DO NOT** use battery charger to supply power to water heater even when testing.
- **DO NOT** install close to opening door or under room slide-out where the vent or inlet louvers can be obstructed.
- This appliance shall be installed by authorised persons only and in accordance with these installation instructions, AS5601.2, local gas fitting regulations, municipal building codes, electrical wiring regulations, local water supply regulations and any other statutory regulations.
- Remove every packaging and transit protection in and outside of the water heater
- The pressure test screw must be properly tightened, and the unit leak tested, prior to completion of commissioning the unit.

### Installation Instructions for the IWH-1.5-13.5 Water Heater

The IWH-1.5-13.5 water heater is designed for easy installation and removal from the exterior of the vehicle. The mounting instructions are for the surface mount door. No other door should be used. Doing so will void the warranty and cause the heater to malfunction and could cause damage or injury.

Please read these instructions before making any modifications to the construction of your caravan or RV.

### Selecting Installation Location

Review the following guidelines carefully before choosing the location for the water heater and ensure the location complies with the requirements of the current edition of AS5601.2 before installation.

The water heater must not be installed in an area where the vent can be covered when any door or access panel on the coach is opened.

The water heater should be located in an area where leakage will not result in damage to other items of, or in the structure. If such an area cannot be avoided, it is recommended that a suitable pan and drain be installed under the heater.

Install the heater as close to the gas supply as practical to minimize length of the gas line.

There must be a minimum of 25 cm of clearance between the vent cover and any other surface.

**Do not** install where the vent is closer than 40 cm from any window or opening into the coach.

**Do not** block or restrict door louvers, this will damage the IWH-1.5-13.5.

Although the IWH-1.5-13.5 can be mounted with zero clearance around the sides, top and bottom, be sure that the installation does not interfere with any wiring, plumbing or cabinets inside the coach.

**Do not** install the water heater or any other appliance where it can vent into an area covered by an awning, canopy or any other enclosure. For better support and ease of installation, install where the bottom of the heater case rests on a floor.

### Installing Heater In The Side Wall Of An RV

The model IWH-1.5-13.5 refers to the heater with a surface mount door. The IWH-1.5-13.5 can retrofit most tank water heaters without side wall modification regardless of side wall framing. It is possible, that you have to use a kind of adapter frame.

#### Surface Mount Installation

- Surround the opening on the skin of the coach with four to six inches of masking tape to protect the skin of the side wall.
- Cut a rectangular hole with a width of 330mm and a height of 330mm at the selected position.
- Push the IWH-1.5-13.5 into the opening. Center the heater in the opening and start a screw in the top center hole.
- Run the screw down but not tight. Apply silicone or other appropriate sealant under the IWH-1.5-13.5 flanges.
- Push the unit into the opening to bed into the sealant. Now screw in the other three center screws.
- Apply silicone or other appropriate sealant heavily in the corners and on the flange around the corner holes.
- Install all the remaining screws and remove excess sealant.

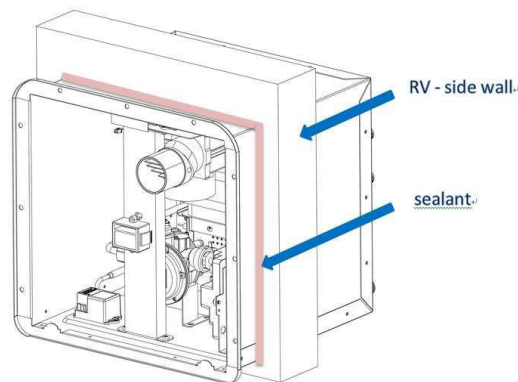

#### Connection of the Gas Supply

Connect an approved gas line at the 3/8" SAE male gas inlet and use an approved sealant for this connection. Due to the high gas rate, we recommend a gas supply pipe of 8mm minimum diameter. Gas pipe sizing and flueing must be in accordance with AS 5601.2.

Ensure the fastener securing the gas line to the unit is done up securely and tested with soapy water or a leak detector, to verify that there are no leaks, as part of commissioning the unit.

### Connection Water of the Supply and Hot Water Outlet

The cold water inlet and the hot water outlet are connected via 2 standard 1/2" male fitting. Use a rubber seal or other removable sealants. Piping and components connected to the heater shall be suitable for use with potable water.

When tightening water connections to the water line, be sure to back up the fittings with a wrench as to not damage the copper water tubing. Re-tighten the compression nuts on the water fittings.

With the power and gas supply to the heater turned off, pressurize the water system, purge off all air and check for leaks.

The water heater is controlled and started by the water flow. If the water flow is higher than 1.5 l/min, the burner starts automatically and heats up the water to the desired temperature.

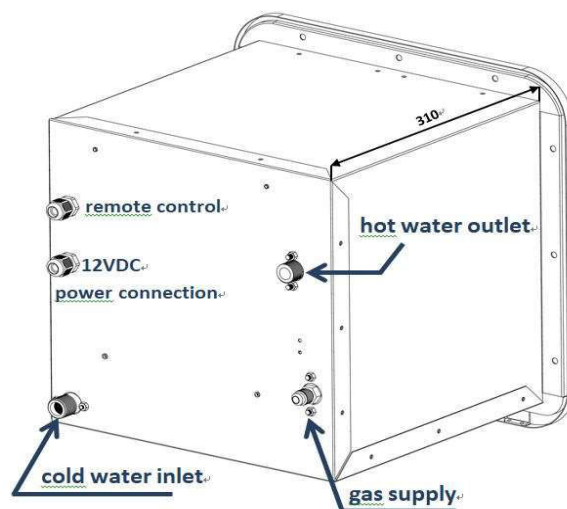

### BACKSIDE VIEW - CONNECTIONS

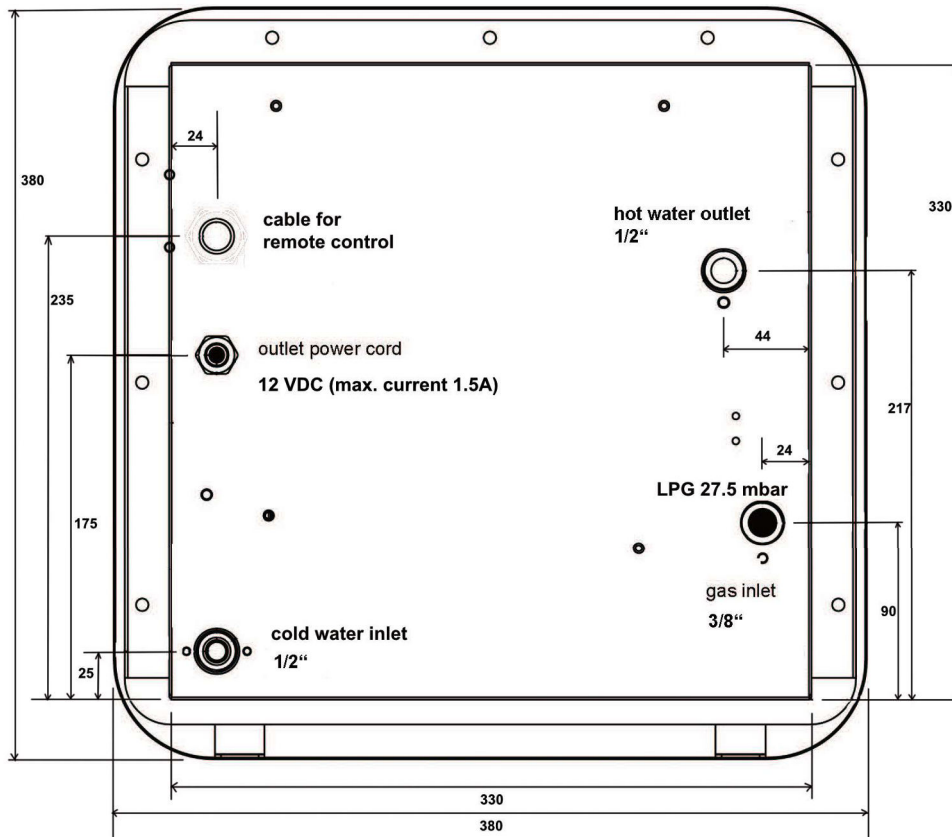

#### Connection Electrical Supply and Remote Control

The water heater is designed for 12 VDC (10...15V, negative ground). The power leads are on the back of the heater and should be connected via a breaking switch to the 12 V system of the RV. The red wire is positive (+) and the black wire is negative (see sticker). A breaking switch is recommended for safety reasons, so the water heater could be switched of separately.

If the leads need to be extended or any wiring is extended or replaced inside the heater, use a minimum of 0.5 mm<sup>2</sup> wire with a temperature rating of 105°C. It is suggested that the heater be connected to a breaker rated at 5 amps.

**DO NOT** connect heater to a power converter without a battery in line or a battery charger. Doing so could damage your heater and void the warranty. Be sure that the heater is connected to a "filtered" (pure DC) circuit of the converter. To test whether the circuit is pure DC, take a voltage reading using a multimeter set on the AC voltage scale. If the reading is more than 1 volt, the circuit is not pure DC voltage and should not be used. (See the tag on red and black power wire on the back of heater)

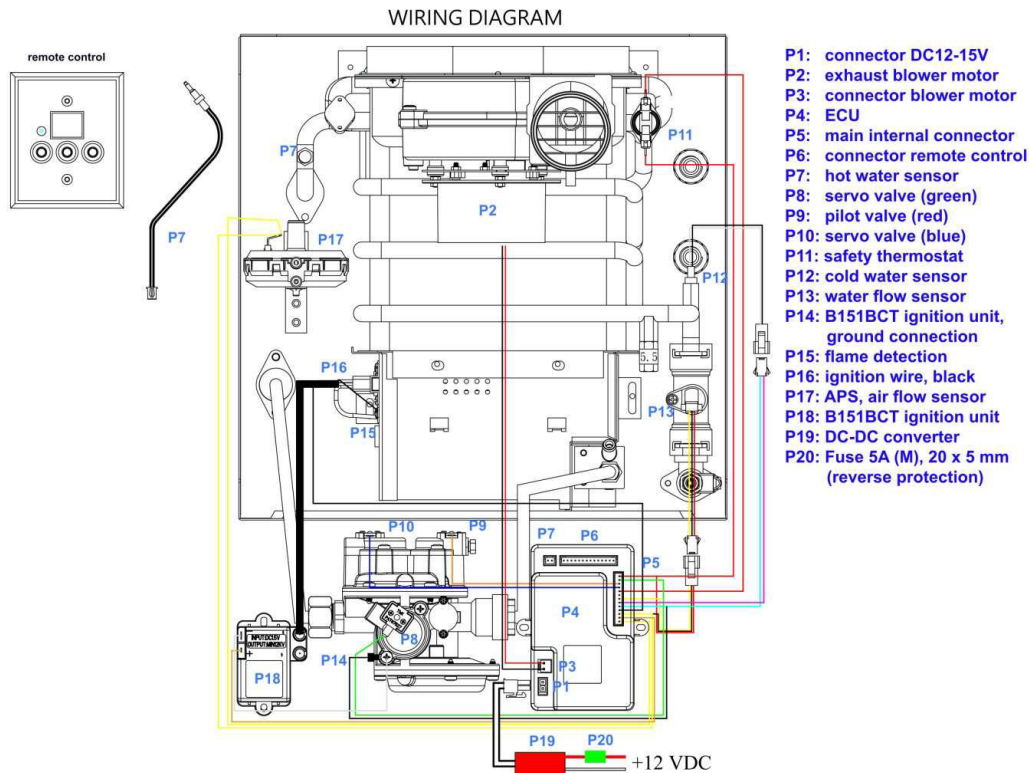

### Operating Instructions and first operation test

Note to installer: You must test the operation of this appliance after installation.

1. Pressurize the water system by turning on pump or city water pressure.
2. Purge all air from system by turning on the taps until a steady stream of water flows from the taps. Turn off taps.
3. Turn on the 12 VDC power supply. A testing sequence on the remote starts and after a few seconds, the display shows the last selected temperature. The production preset water temperature of the water heater is 45° C.  
The selected water temperature is stored in nonvolatile memory. Even after disconnecting the electric power, the former selected temperature will be displayed. This is a very useful feature as you don't have to select your desired temperature again in case of a power loss.  
For colder (blue button) or warmer water (red button) press the buttons till you reach the desired temperature.
4. Turn on the gas supply at the tank and the manual gas valve if installed in system. Heater will remain dormant (and will not use any gas) until a water tap is opened and the heater senses a water flow of at least 1.5 l/min.
5. Turn on the hot water tap (water flows and/or pump starts). The heater will fire up within two seconds and hot water will start to flow from the tap in the time that it takes to get through the plumbing from the heater to the tap. Hot water delivery will continue as long as the water is flowing. Depending on the length of the hot water line, it might take up to 20 seconds until the hot water comes out of the tap.  
After the first installation or when you change the gas bottle, it might need 3-5 trials, until the gas has reached the burner and you have ignition. On the display failure E1 is shown, which means no flame detection. When E1 appears, just turn the water tap on and off to trigger a new ignition sequence.  
After the burner ignites you will see the current temperature on the display. Depending on the water flow and the ambient temperature of the cold water, it will take some seconds, until the control reaches the desired water temperature. If the water temperature does not reach the desired temperature, the water flow may be too high, or you have extremely cold incoming water. Reducing the water flow will allow the outgoing water to reach to the desired temperature.

6. When the hot water tap is turned off, the heater will shut off and remain in “stand-by mode”.
7. With the ON/OFF button of the remote control, you can switch off the water heater so the burner is not activated via the water flow.

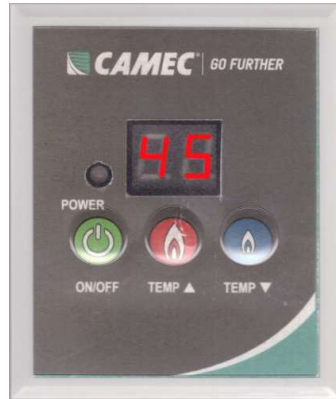

### Troubleshooting

The IWH-1.5-13.5 is equipped with a microprocessor based self-diagnostics system. Possible errors are displayed on the LED display of the remote control.

#### Failure code shown in the display

E1	Burner flame did not ignite within 10 seconds. Check LPG cylinder valve is on or refill LPG cylinder.
E4	Flame controller delivers a signal before water tap is opened.
E5	Broken circuit of NTC (hot water sensor)
E6	Short circuit of NTC or hot water exceeds 85°C
E7	Flameout for many times because of unstable ionization signal.
E8	When power is ON, the water flow is > 1.5 l/min.
E9	Failure of pressure switch or airflow too low
EA	Damaged NTC (cold water sensor)
EB	Damaged CPU or circuit
ED	Memory error of CPU
EE	Damaged CRC

#### Heater does not start when the water turns on:

1. Be sure all electrical connectors are secure and the polarity is correct.
2. Be sure power is on and panel breaker is not tripped.
3. Check electrical contacts in electronics drawer. Be sure the connector with “+” and “-” power wire is plugged into board. Using a voltmeter, check for 12 Volts on this connector.
4. Confirm the water heater is switched on via the ON/OFF button on the remote control.
5. Be sure there is a battery in the system. Never connect the heater directly to a power converter. Some converters have circuits that are not pure DC.

6. Be sure the gas valve at the tank is "On" and there is gas in the tank.
7. Be sure that the water flow is at least 1.5 l/minute.
8. If you have changed the gas bottle, it takes a while until the gas lines are filled with gas and the gas reaches the water heater. If E1 is displayed, there is no flame detection. Close the water tap for a few seconds and open it again. Depending on the length of the gas line, it may take several attempts until you have ignition. When you have flame ignition, you will see the current water temperature rising in the display.

## Maintenance

### Routine Maintenance

All tap aerators and showerheads should be cleaned regularly.

It is recommended that the IWH-1.5-13.5 be inspected by a qualified service technician at least once a year. Particular attention should be paid to the following:

1. Be sure that the air inlet openings and flue area (screen) are clear of any debris or obstructions, (leaves, bug nests, spider webs, etc.)
2. Check that heater mounting is still secure to the RV and that there are no areas for potential water leaks.
3. Open the cover of the heater and inspect for debris or obstructions under the burner, around the blower motor or in flue hood.
4. Visually inspect wiring. Be sure there is no chafing of the insulation. Be sure that the direct spark ignition, the ground and the flame detection cable is secured to the electrodes at the left side of the burner.
5. Inspect the interior surface of the housing for any cracks or corroded areas that could allow penetration of gases into or out of the interior of the vehicle. Check especially around the Hot Water, Cold Water, Gas and electrical connections.
6. Check for soot around the flue. Soot is a sign of incomplete combustion and a qualified service technician should be notified to correct the problem.
7. Check the pressure relief valve if it's tight under normal conditions. Test also the operation of the drain valve for proper function.  
Note: **DO NOT** open the drain valve during the operation of the water heater.
8. Turn on the power to the water heater and open a hot water tap to inspect the flame of the burner. The flame should be of normal bluish appearance that indicates proper combustion. You can observe the flame through a line of small holes at the front side of the burner.
9. Depending on the environmental conditions, the exhaust pipe might get a matt surface out of aluminum oxide. This is normal and a kind of protection surface.

### Winterizing and draining water

It is not recommended that you operate the water heater at below zero temperatures. Any freezing of the water heater or other plumbing components can cause severe damage that is not covered by warranty.

**NOTE:** Under no circumstances, however, should you travel under freezing conditions without first draining water from the unit.

To drain the system:

1. Turn off water pump and the power and gas to the heater. Open the drain valve by turning the handle to a 90° position from the normal position.
2. Open drain valve that was installed at hot water outlet fitting of heater.
3. Open at least one hot and cold water tap in the coach. This should drain the system.

Before storing the system for the winter season, the plumbing system must be winterized.

This can be done by either of the following methods:

All water should be drained from the system. To do this, open one tap at a time, using compressed air (less than 2 bar) to purge the system of all water.

Recommendations of your RV manufacturer should be followed. Since the IWH-1.5-13.5 has no storage tank, there is no need for a water heater bypass kit. It holds less than 0.3L of water.



The water system can be filled with RV, non-toxic anti-freeze, which doesn't affect copper and brass. When you see the anti-freeze coming from the hot water tap, the heater is protected.

### Specifications

Gas Type	Universal LPG
Supply Pressure	2.75 kPa
Test Point Pressure	2.30 kPa
Maximum Input (propane)	13.65kW
Nominal Gas Consumption	49.14 MJ/h
Injector	Ø1.06mm x 4
Efficiency	> 90%
Minimum Water Flow Rate	1.5 l/min
Shut Down Water Flow rate	1.0 l/min
Maximum Water Pressure	500 kPa
Minimum Water Pressure	5 kPa
Selectable Water Temperature	35 to 60°C
Water Heating Capacity	5.0 l/min at 37°C
Supply Voltage	10.5 to 15.0 VDC
Maximum Current	1.5A





For further information or assistance, please contact our National Customer Support Team or visit Camec website.

1. Australia on 1300 422 632 or [camec.com.au](http://camec.com.au)
2. New Zealand on 09 257 2419 or [camec.co.nz](http://camec.co.nz)

For any retail or trade enquiries, please contact our Sales office.

**CAMEC VICTORIA**

47-63 Remington Drive  
Dandenong South VIC 3175

23-27 Freight Drive  
Somerton VIC 3062

Phone: 1300 422 632

Email: [camec@camec.com.au](mailto:camec@camec.com.au)

**CAMEC NEW ZEALAND**

44 Montgomerie Road  
Mangere Auckland 2022

Phone: 09 2572417

Email: [sales@camec.co.nz](mailto:sales@camec.co.nz)

**CAMEC NEW SOUTH WALES**

Units 2 & 3

No. 1 Koonya Circuit

Caringbah NSW 2229

Phone: (02) 9525 2588

**CAMEC QUEENSLAND**

Building 3

Archerfield Industrial Park

Cnr Kerry & Beaudesert Road

Archerfield QLD 4108

Phone: (07) 3710 9000

**CAMEC WESTERN AUSTRALIA**

190 Welshpool Road

Welshpool WA 6106 Australia

Phone: (08) 9351 0044